

## KOCKON M2 105 ULTIMATE PL-CAP

Anti-sihon device featuring progressive filler float, quick mounting system and reduced diameter solid alloy body and thermoplastic cap mounting ring .For tanks with 2-point bayonet opening diameter 105 mm. Supplied with it's own dedicated fuel cap.

For tanks with 2-point baionet opening  $\varnothing$ 105 mm DAF: all models MAN: all models VOLVO: all models  
MERCEDES: all models IVECO: Stralis, EuroStar, EuroTec, Trakker, EuroTrakker, EuroCargo with metal fuel tanks  
RENAULT: Premium, Magnum, Midlum with metal fuel tanks

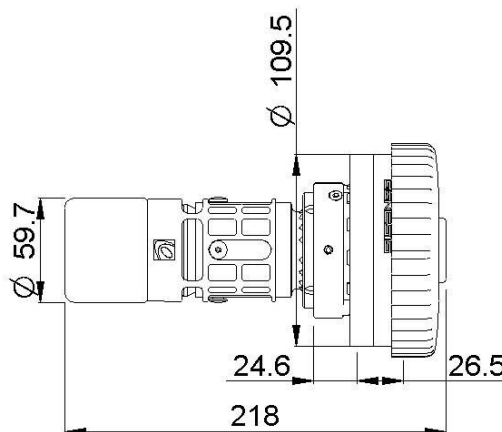
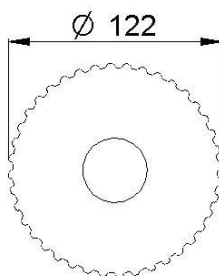

CODE	DESCRIPTION
824510013	Anti-sihon device featuring progressive filler float, quick mounting system and reduced diameter solid alloy body and thermoplastic cap mounting ring .For tanks with 2-point bayonet opening diameter 105 mm. Supplied with it's own dedicated fuel cap.

-->

### TECHNICAL DATA



#### SPECIFICATIONS







Main body material	Aluminium
Cage and float material	Acetalic resin and Polyethylene LD, suitable for immersion in the fuel
Gasket material	HNBR, suitable for immersion in the fuel
Finishing	Anodized
Weight	1,25 kg

#### PACKAGING





Assembly	The product is supplied ready to use
Package type	Carton box
Package dimensions	120x290x120 mm
Package contents	Anti theft device, lid, adapter, multilanguage manual
Multipack	6 pcs in master carton box
Multipack dimensions	390x260x330 mm

### ACCESSORIES

					available[M/Y]	
code	version	item	description	qty	from	to
 054501012	V1.1	GENESIS UNIVERSAL MOUNTING TOOL	Tool to assist installation of Kockon products		10/14	
 784515100	V1.0	AL-CAP KIT FOR M2 BASE MODULE	Upgrade Kit which fits on Kockon Mach II base module. The kit is composed of an aluminium cap mounting ring which fixes using 4 screws (supplied with kit) and an o-ring which seats the cap mounting ring onto the upper plate of the Kockon. Includes a low profile locking cap with 105 type 2 point bayonet mount.		11/14	
 784515101	V1.0	UNI-CAP KIT FOR M2 BASE MODULE	Upgrade kit for Kockon Mach II base modules. Consists of an aluminium high profile cap mounting ring and o ring seal for seating onto the upper place of the Kockon base module. Made to allow use of the majority of original vehicle fuel caps which would normally not fit on Mach II Kockons due to their height.		11/14	

	784516200 V1.0	BE4P Upgrade Kit for MII SYSTEM BASE MODULES	Upgrade Kit which fits on Kockon Mach II base module. The kit is composed of an aluminium 4 point bayonet cap mounting ring which fixes using 4 screws (supplied with kit) and an o-ring which seats the cap mounting ring onto the upper plate of the Kockon. It allows use of the original die cast bayonet cap.	11/14 05/15
	786010010 V1.0	ZIP SAFETY CAP UPGRADE KIT	Upgrade kit for Kockon Mach II base modules. Consists of a self closing ventilated fuel cap without lock which can be fitted through a rapid mounting procedure by the end user without having to remove the Kockon from it's installed position.	11/14 05/15
	786010011 V1.0	ZIP LOCK SAFETY CAP UPGRADE KIT	Upgrade kit for Kockon Mach II base modules. Consists of a self closing ventilated fuel cap with lock which can be fitted through a rapid mounting procedure by the end user without having to remove the Kockon from it's installed position.	11/14 05/15
	786010019 V1.0	ZIPPER WIRED UPGRADE KIT	Upgrade kit for Kockon Mach II base modules. Consists of a self closing ventilated fuel cap with a built in electronic activation switch and wire connection which can be used to trigger events upon fuel cap opening. Can be fitted through a rapid mounting procedure by the end user without having to remove the Kockon from it's installed position.	11/14 05/15
	786010029 V1.0	ZIPPER WIRELESS UPGRADE KIT	Upgrade kit for Kockon Mach II base modules. Consists of a self closing ventilated fuel cap with a built in electronic activation switch and wireless transmitter which can be used to trigger events upon fuel cap opening. Includes it's own receiver unit and buzzer which warns the vehicle cabin occupant of cap opening. Can be fitted through a rapid mounting procedure by the end user without having to remove the Kockon from it's installed position.	11/14 05/15
	786015101 V1.0	XXL-CAP KIT W/LOCK FOR M2 XL BASE MODULE	Upgrade Kit which fits on Kockon Mach II base module. The kit is composed of a extra-extra low thermoplastic cap mounting ring which fixes using 4 screws (supplied with kit) and a dedicated gasket which seats the cap mounting ring onto the upper plate of the Kockon. Includes a low profile locking cap with automotive type 2 point bayonet mount and locking key.	09/15

## SPARE PARTS

code	version	item	description	available[M/Y]	
				from	to
	584500001	ADAPTER FOR 25MM DIA. FUEL NOZZLE	Adapter for nozzle Ø 25 mm		
	050920001	REPLACEMENT FUEL CAP 105 BAYONET	Locking Cap for 105 bayonet mounts.		
	050707011 V1.0	GASKET KOCKON 105 UNIVERSAL	Mounting seal 105	03/10	
	050702037 V1.0	OR NBR 3375 DI 94.92 S 2.62	OR NBR 3375 DI 94.92 S 2.62	11/14	07/15